

1

2

3

4

5

6

A

A

B

B

C

C

D

D

E

E

F

F

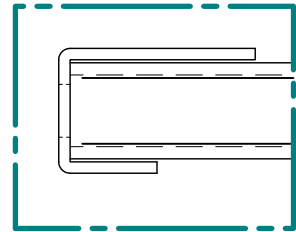

DETAIL D
1:1

TYPICAL
WELD EVERY
HORIZONTAL & VERTICAL BAR
SECTION B-B
1:4

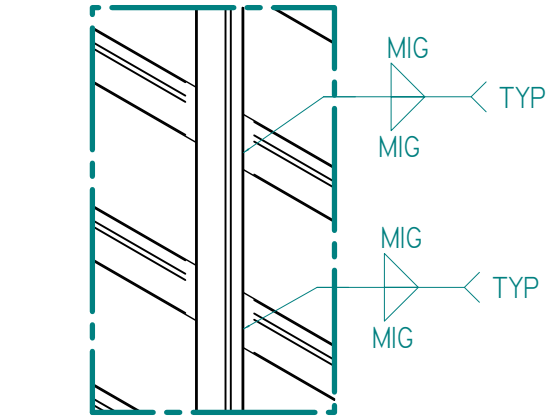
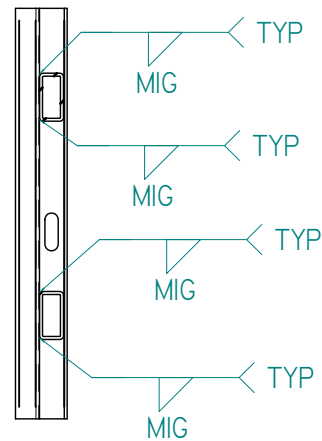

TYPICAL
WELD EVERY
HORIZONTAL & VERTICAL BAR
DETAIL C
1:4

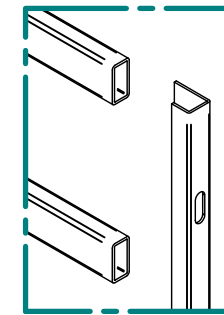

DETAIL A
1:4

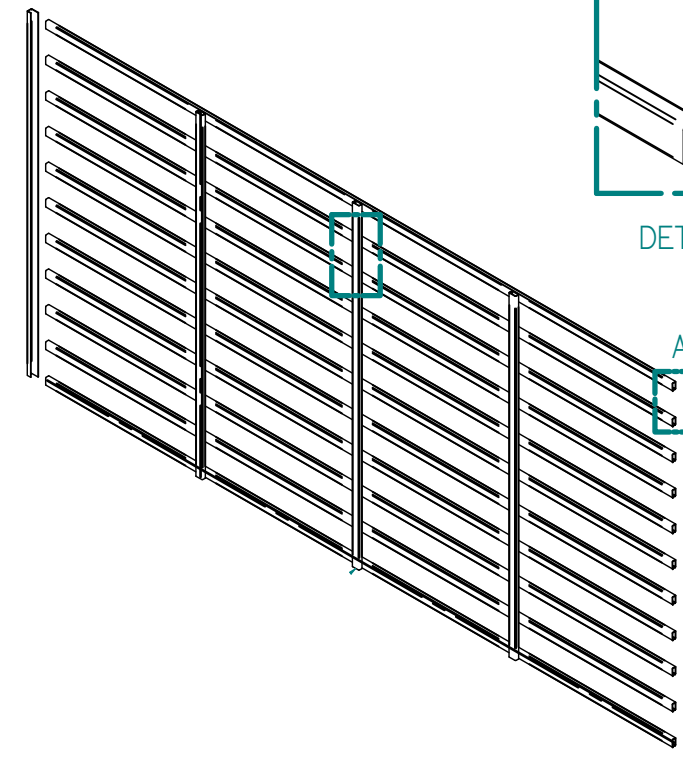

EXPLODED
PICTORIAL VIEW
NTS



TOP VIEW

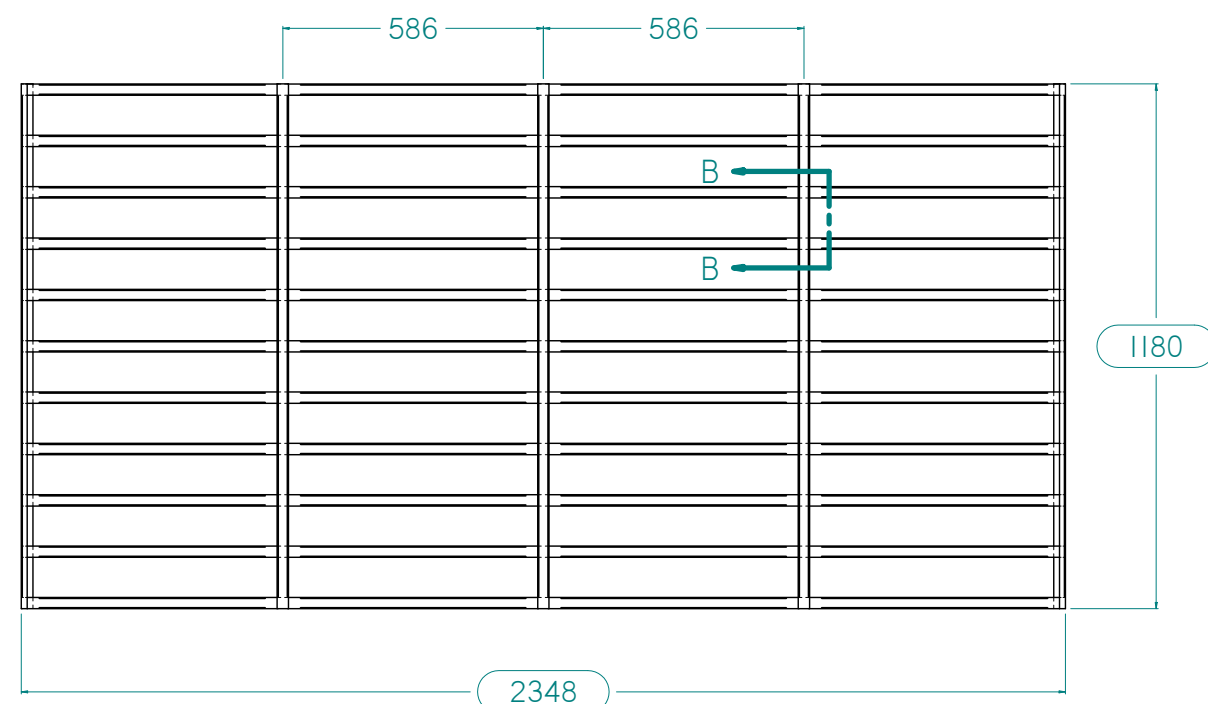

FRONT VIEW

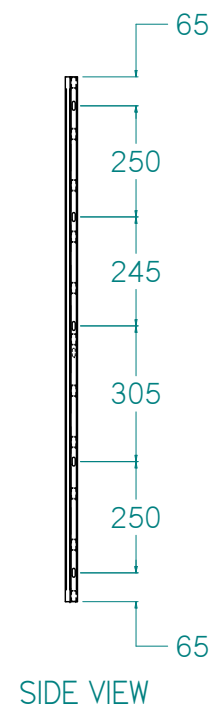

SIDE VIEW

WELDED
PARTS ONLY
FRONT VIEW
1:20

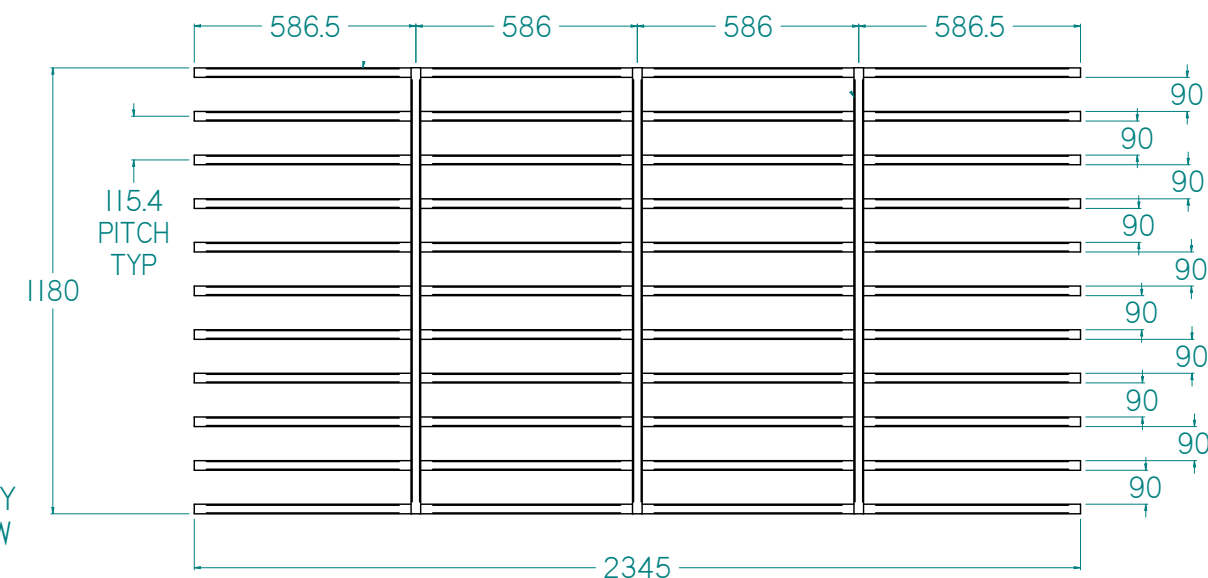

1

2

3

4

5

6